



VISIO

APPLICATION RATE MONITOR VERSION

Software rel. 2.3.x

CONTENTS

• Legend of symbols	3
INTRODUCTION	4
Product description	4
INTENDED USE	4
CONTENT OF THE PACKAGE	4
PRECAUTIONS	4
RISKS AND PROTECTIONS BEFORE ASSEMBLY	5
Positioning	5
Power supply and sensor connection	5
ASSEMBLY DIAGRAMS	6
CONTROLS IN THE MENU	7
First switching on	7
Controls in the menu	8
Work parameters	9
MENU STRUCTURE	10
PRELIMINARY SETUP FOR USE	11
Flowrate alarms	11
PRELIMINARY SETUP FOR USE	12
Speed alarms	12
Application rate alarms	13
Sensors	14
Flowmeter calibration	15
Speed sensor calibration	17
Language	20
Units of measurement	21
Units of measurement	22
Display contrast	25
Alarm tones	26
Keytones	26
Display settings	27
Boom length	28
Operating mode	29
Setup management	30
Test menu	32
USE	34
Partial totalizer reset	34
MAINTENANCE / DIAGNOSTICS / REPAIRS	35
Troubleshooting	35
END OF LIFE DISPOSAL	35
TECHNICAL DATA	36
Device technical data	36
Setup menu	37
GUARANTEE TERMS	38

• Legend of symbols



= **Generic danger**



= **Warning**

This manual is an integral part of the equipment to which it refers and must accompany the equipment in case of sale or change of ownership. Keep it for any future reference; ARAG reserves the right to modify product specifications and instructions at any moment and without notice.

INTRODUCTION

Product description

VISIO is a very compact and accurate top-notch multifunction display, able to display any kind of information concerning agricultural treatments.

Operator can select the required function via software.

It can display several types of values, which change according to set operating mode and type of connected sensors.

INTENDED USE

This device is designed to work on agricultural machinery for spraying and crop spraying applications.

CE The machine is designed and built in compliance with EN ISO 14982 standard (Electromagnetic compatibility - Forestry and farming machines), harmonized with 2004/108/EC Directive.

CONTENT OF THE PACKAGE

The table below indicates the components that you will find in the VISIO package:

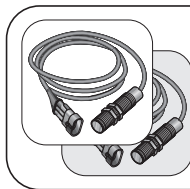

Power cable, sensors and connection cables to be connected to VISIO must be ordered separately.

Legend:

- 1 VISIO
- 2 Fixing kit
- 3 Instruction manual (on CD-ROM)
- 4 Installation sheet

PRECAUTIONS



- Do not aim water jets at the equipment.
- Do not use solvents or fuel to clean the case outer surface.
- Do not clean equipment with direct water jets.
- Comply with the specified power voltage (12 VDC).
- In case of voltaic arc welding, remove connectors from VISIO and disconnect the power cables.
- Only use ARAG genuine spare parts and accessories.

RISKS AND PROTECTIONS BEFORE ASSEMBLY



All installation works must be done with battery disconnected, using suitable tools and any individual protection equipment deemed necessary.

Positioning

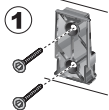

1) Set mounting rail in cabin and fasten it with the relevant screws (1), in a position where VISIO can be easily seen and at hands' reach, but away from any moving organs.

2) Secure VISIO to rail and push down until locked in place.

3) Fasten wiring so that it does not interfere with any moving parts.

Power supply and sensor connection





Sensors and power supply must be installed and connected by qualified personnel. VISIO must be exclusively connected to ARAG equipment. **WHEN ARC WELDING IS REQUIRED, MAKE SURE THAT EQUIPMENT POWER IS SWITCHED OFF; DISCONNECT POWER CABLES IF NEEDED.**

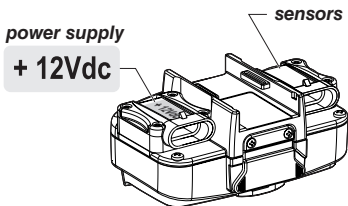

ARAG is not liable for damage to the system, persons, animals or property caused by VISIO wrong or unsuitable assembly. Failure to observe the above instructions automatically voids the warranty.



Wire color (power cable)	Connection of
red	 positive
black	 negative
green	counting abort - ground connection
yellow	counting abort - connection +12VDC

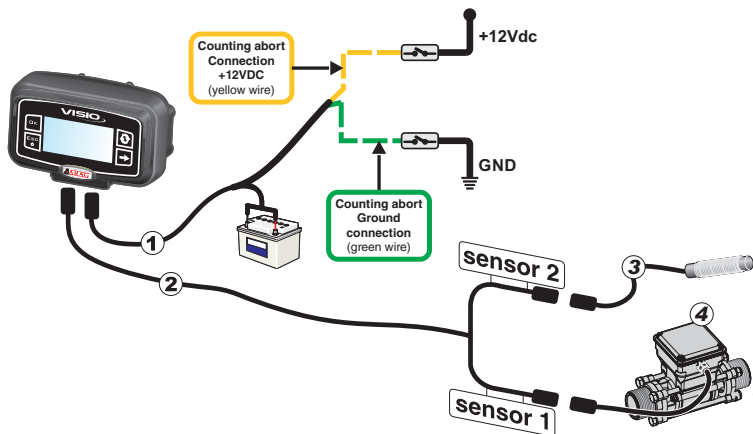

Legend:

- 1) Power cable
- 2) Connection cable for double sensor
- 3) Speed sensor
- 4) Flowmeter

CONTROLS IN THE MENU

First switching on



At first switching on, VISIO will run a guided procedure allowing user to set the device's basic settings.

Press  to scroll through items, **OK** to save and move on to next setting, or **ESC** to go back to previous setting.



WARNING: Before changing operating mode, make sure that all sensors / flowmeters are **DISCONNECTED** from the device.



In the following pages, according to the set operating mode, some menu items could slightly differ from the shown ones.



SWITCHING ON

A Press for 1 second;

B Press the key to view the various values in extended mode, in a sequence (on display central part).

Every time the device is switched on, it will shortly show a page with the name of device and software version.

SWITCHING OFF

A Press for 2 seconds.

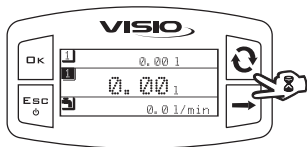

ACCESS TO SETUP MENU

From the main page, press keys at the same time for 2 seconds to open the Setup Menu.

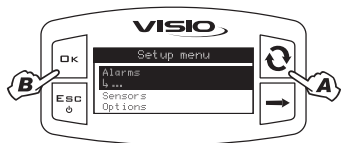

SELECTION AND ACCESS TO MENU ITEMS

A Press a few times to scroll through items (selected item is indicated by a black line);

B Press to open the selected menu item.



The three dots under an item indicate presence of another setup menu.



EDITING A VALUE

- A** Press to move through digits;
- B** Press a few times to edit the highlighted digit;
- C** Press to confirm. The display goes back to previous page;
- D** Press to exit page without confirming modification.



Edited value must fall within the range shown.

Work parameters

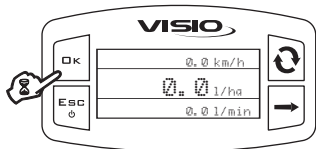

From the main page, press key for two seconds to open **Work Parameters** menu, and set values for **Flow correction**.

MENU STRUCTURE

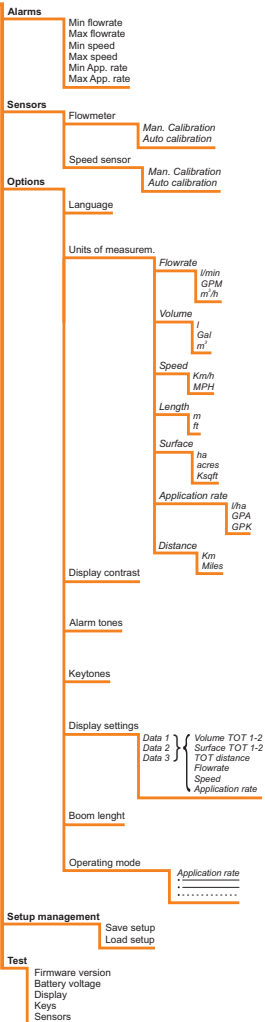
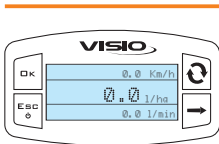

Flowrate alarms

Set minimum and maximum flowrate thresholds for alarm message.



1) Open Alarm menu (Setup menu > Alarms).



Minimum and maximum flowrate alarms are set in the same way.

The display will show the current setting below the selected item.

Press **OK** to edit the selected menu item.

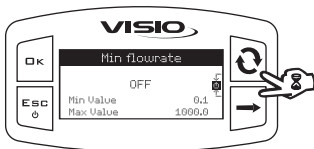

2) To activate the alarm, press  and



at the same time until message **OFF** goes off and rate alarm value is displayed instead.

Carry out the same procedure to disable alarm again.



3) Set alarm value:

A) Press to move through digits.

B) Press a few times to edit the highlighted digit.

C) Press to save changes, or

D) Press to quit the page without confirming changes.

Speed alarms

Set minimum and maximum speed thresholds for alarm message.

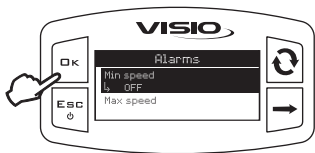

1) Open Alarm menu (Setup menu > Alarms).



Minimum and maximum speed alarms are set in the same way.

The display will show the current setting below the selected item.

Press **OK** to edit the selected menu item.

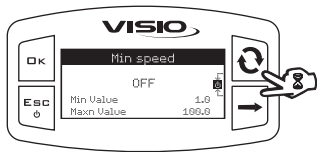

2) To activate the alarm, press  and



key at the same time until message

OFF goes off and speed alarm value is displayed instead.

Carry out the same procedure to disable alarm again.



3) Set alarm value:

A) Press  to move through digits.

B) Press a few times to edit the highlighted digit.

C) Press  to save changes, or

D) Press  to quit the page without confirming changes.

Application rate alarms

Set the desired alarm display thresholds for minimum and maximum application rate.

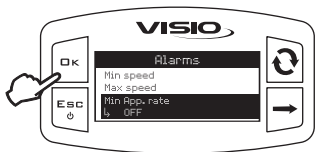

1) Open Alarm menu (Setup menu > Alarms).



Minimum and maximum application rate alarms are set in the same way.

The display will show the current setting below the selected item.

Press **OK** to edit the selected menu item.

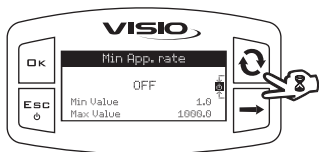

2) To activate the alarm, press  and



at the same time until message **OFF** goes off and application rate alarm value is displayed instead.

Carry out the same procedure to disable alarm again.



3) Set alarm value:

A) Press to move through digits.

B) Press a few times to edit the highlighted digit.

C) Press to save changes, or

D) Press to quit the page without confirming changes.

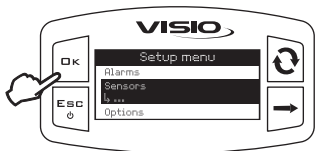

1) Open Sensors menu (Setup menu > Sensors).

The menu items displayed below change according to the set operation mode: when more items are available, select the desired one and press **OK** to edit it.

 Due to the different system configurations (tubes, valves, etc.) rate reading could not be correct. It is therefore recommended to perform a spraying test. If measured value is different from actual value, change the rate constant through an automatic calibration procedure or manually calculate the constant.

Automatic calibration

Let a previously measured quantity of fluid go through the system or a quantity that could be measured through another system. **The higher the quantity of fluid used to perform the calibration procedure, the more accurate the calibration.**

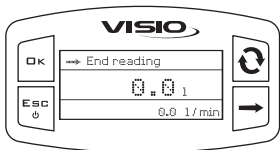

1) Open automatic calibration menu (Setup menu > Sensors > Flowmeter > Auto Calibration).

As soon as menu is open, the equipment is ready to start measuring with no further controls being required.

2) Start liquid flow in the system. The display will start showing the increasing value of the measured fluid quantity. As soon as fluid flow is over, the displayed counter will stop.



3) Now press **OK**. At the bottom of the display **Stabilization**, message will turn on and equipment will then show the page on the side.

4) Enter previously measured quantity of fluid:

A) Press to move through digits.

B) Press a few times to edit the highlighted digit.

C) Press to complete the calibration procedure, or

D) Press for 1 second to cancel the calibration procedure.

① Setting the fluid quantity actually passed through flowmeter during the calibration procedure.

② Viewing the fluid quantity read by flowmeter during the calibration procedure.

If equipment does not detect any flow after calibration is started (and displayed value remains 0), press **OK** to quit the calibration procedure without saving.

If the device continues to detect flow after **OK** was pressed, the error message **Stop flow!** will be displayed after a few seconds. As soon as flow is stopped, reading will stabilize, as per standard procedure.

 In case **VISIO** calculates a value out of the range that can be set by means of the manual calibration, the calculated value will not be set.

Manual calibration

In order to manually set rate constant, calculate and set suitable constant using the following formula:

$$\frac{[\text{quantity measured by equipment}]}{[\text{actually sprayed quantity}]} \times [\text{constant indicated on flowmeter body}]$$



1) Open manual calibration menu (Setup menu > Sensors > Flowmeter > Man. calibration).

Under Calibration menu, select Man. calibration, to view currently set constant value below the item.

Press **OK to edit the value.**

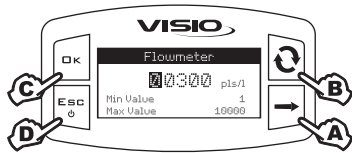

 **For flowmeter constant value, refer to the corresponding manual.**

2) Set flowmeter constant value:

A) Press to move through digits.

B) Press a few times to edit the highlighted digit.

C) Press to save changes, or
D) Press to quit the page without confirming changes.

Speed sensor calibration

VISIO calculates the information concerning the speed thanks to pulses received by the sensor installed on the wheel.

To perform calibration, proceed as follows:

- Measure a straight path at least 100 m (300 feet) long.

The longer the distance traveled, the more accurate the wheel constant calculation.

- Take measurements with tyres at the operating pressure.

This test must be performed on medium-hard terrain; for application to very soft or very hard terrain, rolling diameter may vary, leading to inaccurate output calculation; when this is the case, repeat the procedure.

During the test, cover the distance with the tank filled up to half capacity with water.

Calculate and save the wheel constant according to the procedure below:

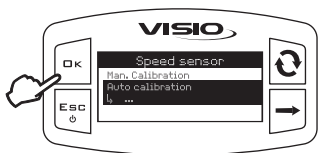

1) Open automatic calibration menu (Setup menu > Sensors > Speed sensor > Auto Calibration).

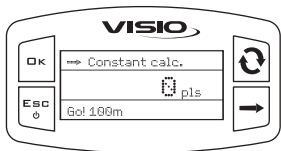

As soon as menu is open, the equipment is ready to start measuring with no further controls being required.



Cover the requested distance: the number of pulses will increase during the path and the bottom area will indicate instant speed reading.

Stop the tractor at the end of the distance.

 If a malfunction occurs, the message **Check sensor!** will be shown in the top part of the display.



Press **OK** to stop the counting. The display will go back to the previous menu and will show the acquired value.

In case of measurement errors, or if it is necessary to stop the calibration, press **ESC** for 2 seconds to quit the calibration procedure without saving.

In this case, the value will be the one previously measured, or the default value.

Manual calibration allows to enter the wheel constant value calculated with the suitable formula:

$$K_{\text{wheel}} = \frac{\text{distance traveled (cm)}}{\text{no. of detection points} \times \text{wheel rpm}}$$

<distance traveled> distance expressed in cm covered by the wheel along measurement travel;

<no. of measurement points> number of measurement points (e.g., magnets, bolts, etc.), mounted on wheel;

<no. of wheel revolutions> number of wheel revolutions required to travel measurement distance.

The wheel constant can be calculated with a good approximation by detecting the distance traveled by the wheel with the speed sensor.



1) Open manual calibration menu (Setup menu > Sensors > Speed sensor > Man. Calibration).

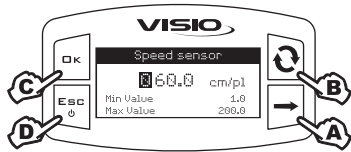

Cover the requested distance. Stop the tractor at the end of the distance and calculate wheel constant (**K_{wheel}**).

- 2) Set wheel constant value:
- A) Press to move through digits.
 - B) Press a few times to edit the highlighted digit.
 - C) Press to save changes, or
 - D) Press to quit the page without confirming changes.

Language

Set the desired language.



Open language setting menu (Setup menu > Options > Language).

The display will show the current setting below the selected item.

Press **OK** to edit language.



1) Select a language through .

2) Press **OK** to save, or **ESC** to quit without saving.

Units of measurement

Set unit of measurement for the values detected by the device.

Flowrate units of measurement

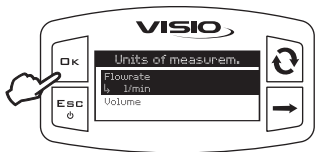

- 1) Open instant rate unit of measurement setting menu (Setup menu > Options > Units of measurement. > Flowrate).

The display will show the current setting below the selected item.

Press **OK** to select flowrate unit of measurement.

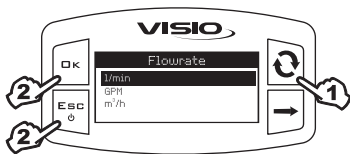

- 1) Select a unit through .

2) Press **OK** to save, or **ESC** to quit without saving.

Volume units of measurement

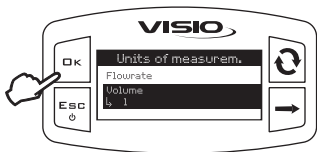

- 1) Open volume unit of measurement setting menu (Setup menu > Options > Units of measurement. > Volume).

The display will show the current setting below the selected item.

Press **OK** to select volume unit of measurement.

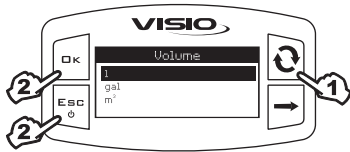

- 1) Select a unit through .

2) Press **OK** to save, or **ESC** to quit without saving.

Units of measurement

Set unit of measurement for the values detected by the device.

Speed units of measurement

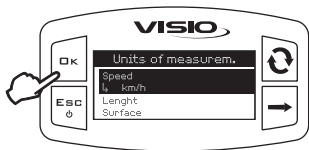

Open speed unit of measurement setting menu (Setup menu > Options > Units of measurem. > Speed).

The display will show the current setting below the selected item.

Press **OK** to select speed unit of measurement.



1) Select a unit through .

2) Press **OK** to save, or **ESC** to quit without saving.

Length units of measurement

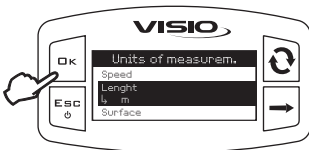

Open length unit of measurement setting menu (Setup menu > Options > Units of measurem. > Length).

The display will show the current setting below the selected item.

Press **OK** to select length unit of measurement.

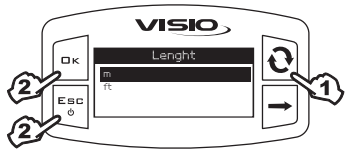

1) Select a unit through .

2) Press **OK** to save, or **ESC** to quit without saving.

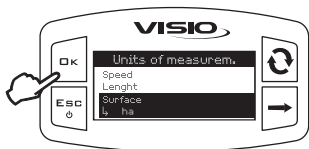

Open surface unit of measurement setting menu (Setup menu > Options > Units of measurement. > Surface).

The display will show the current setting below the selected item.

Press **OK** to select surface unit of measurement.



1) Select a unit through  .

2) Press **OK** to save, or **ESC** to quit without saving.

Application rate units of measurement

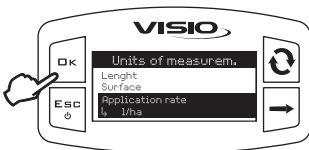

Open application rate unit of measurement setting menu (Setup menu > Options > Units of measurement. > Application rate).

The display will show the current setting below the selected item.

Press **OK** to select application rate unit of measurement.



1) Select a unit through  key.

2) Press **OK** to save, or **ESC** to quit without saving.

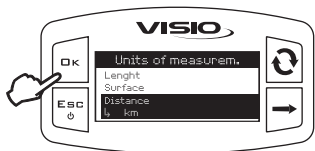

Open distance unit of measurement setting menu (Setup menu > Options > Units of measurement. > Distance).

The display will show the current setting below the selected item.

Press **OK** to select distance unit of measurement.



1) Select a unit through .

2) Press **OK** to save, or **ESC** to quit without saving.

Display contrast

Set display contrast.

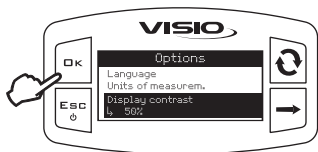



Open display contrast menu (Setup menu > Options > Display contrast).

The display will show the current setting below the selected item.

Press **OK** to edit the selected menu item.



1) Set a value through . Every time you press it, value will increase by 5% up to 100%. Use key  to decrease value by 5%.

2) Press **OK** to save, or **ESC** to quit without saving.

Alarm tones

Enable/disable the alarm tones.

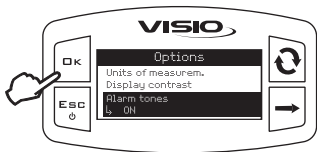

Open alarm tones menu (Setup menu > Options > Alarm tones).

The display will show the current setting below the selected item.

Press **OK** to edit the selected menu item.



1) Set status through .

2) Press **OK** to save, or **ESC** to quit without saving.

Keytones

Enable/disable keytones.

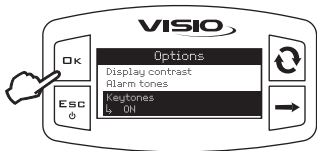

1) Open keytones menu (Setup menu > Options > Keytones).

The display will show the current setting below the selected item.

Press **OK** to edit the selected menu item.



1) Set status through .

2) Press **OK** to save, or **ESC** to quit without saving.

Display settings

The main page shows the display divided into three horizontal parts.
Every sector can be assigned the desired value.

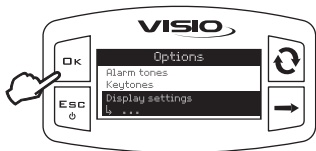

Open Display settings menu (Setup menu > Options > Display settings).
Press **OK** to edit the selected menu item.



1) Select value through .
2) Press **OK** to edit, or **ESC** to quit without saving.

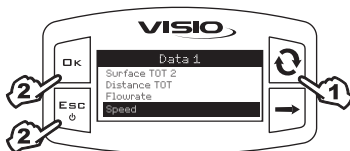

1) Set sector to the required value through .
2) Press **OK** to save, or **ESC** to quit without saving.
Carry out the same procedure for the other 2 values.

Boom length

Set boom length.

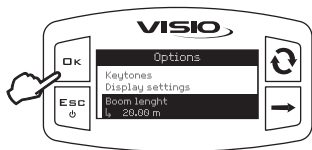

1) Open the boom length menu (Setup menu > Options > Boom length).

The display will show the current setting below the selected item.

Press **OK** to edit the selected menu item.



2) Set boom length:

A) Press to move through digits.

B) Press a few times to edit the highlighted digit.

C) Press to save changes, or

D) Press to quit the page without confirming changes.

Operating mode

Set required operating mode.

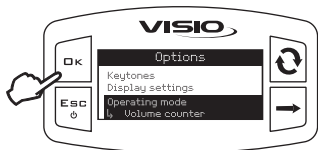

Open operating mode menu (Setup menu > Options > Operating mode).

The display will show the current setting below the selected item.

Press **OK** to change the operating mode.



1) Select the required operating mode

through .

2) Press **OK** to save, or **ESC** to quit without saving.

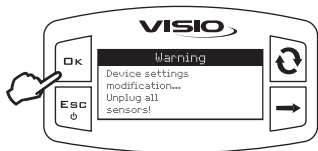

WARNING: Once **OK is pressed, the page on the side will be displayed.**

Before changing operating mode, make sure that all sensors are DISCONNECTED from the device.

Press **OK** to confirm changes.

Connect the sensors REQUIRED FOR THE SET OPERATING MODE.

Setup management

VISIO settings can be loaded from or saved on a USB pen drive in order to reconfigure it if required, fix problems or set another VISIO with no need to repeat all manual operations.



Once installation is completed, and VISIO operation has been checked, we recommend to save all settings onto a USB pen drive.

To be able to use the following functions it is necessary to insert a USB pen drive in the relevant port at the bottom of VISIO.



1) Open Setup management menu (Setup menu > Setup management).

Press **OK** to edit the selected menu item.



Load setup

Allows to select a configuration file saved in the USB pen drive and to set VISIO again.

WARNING: By loading the **SETUP.BIN** file contained in the USB pen drive onto the VISIO, all current settings will be lost.

1) Select the desired control through  key.

2) Press **OK** to confirm loading, or **ESC** to quit without saving.

The **SETUP.BIN** file can be loaded only if it is saved in the USB pen drive root directory.

If setup download involves changing operating mode and using different sensors than the ones in use, make sure that all sensors are **DISCONNECTED** from the device.

Press **OK** to confirm loading.

Reconnect sensors.



Save setup

Allows saving VISIO configuration file on the USB pen drive: it will be possible to load it again any time the same settings need to be retrieved.

1) Select the desired control through



key.

2) Press **OK** to confirm saving, or **ESC** to quit without saving.



If a SETUP.BIN file is already present in the USB pen drive root directory, the file will be overwritten.

Test menu

This menu allows user to view some data and carry out an operation test of VISIO:

- Firmware version:

the display shows the firmware version installed.

- Battery voltage:

the display shows the power voltage of the device.

Display test

Display test checks the device display correct operation.

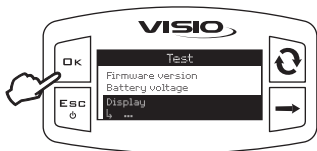

1) Open display test menu (Setup menu > Test > Display).

Press **OK** to perform the test.

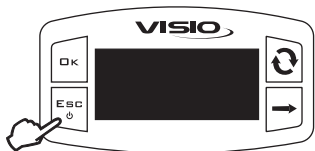

All pixels on display are turned on.

Press **ESC** to go back to previous page.

Keys test

Keys test checks the device keys correct operation.

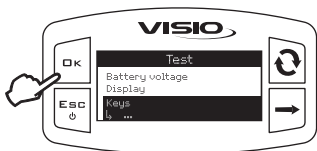

Open keys test menu (Setup menu > Test > Keys).

Press **OK** to perform the test.



1) Press any key and the corresponding display area will turn on.

Press **ESC** to quit: as soon as you acknowledge the switch-on on of the corresponding area on the display, device will go back to previous page.

Sensors test checks correct operation of the sensors connected to the device.

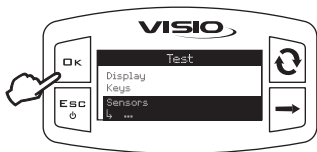

Open sensors test menu (Setup menu > Test > Sensors).

Press **OK** to perform the test.

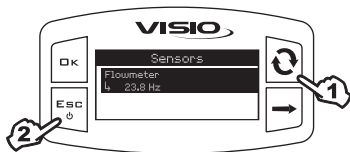

The display will show the current sensor reading below the selected item.

1) Several sensors could be displayed, depending on the set operating mode. In this case, select required sensor

through .

2) Press **ESC** to quit.



In the 3 areas of the monitor, VISIO will display the parameters set in the **Display settings** menu.

Press  key several times to view a value in extended mode until value is on display central part.

Partial totalizer reset



To reset a totalizer you must view it in extended mode.

Press key several times until value to be reset is at the central area of the display.

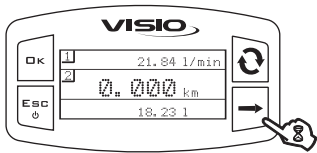

Press  key for two seconds.

Totalizer resets.

 **Setting can or cannot be reset, depending on set value.**

Symbol ----- indicates that flowrate or totalizer exceed maximum value that can be displayed.

Totalizers have a floating point and show a maximum of 4 digits. Two decimals are shown up to 999.99. One decimal is shown after that and 0 decimals are shown when value reaches 10,000.

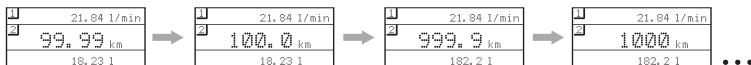

MAINTENANCE / DIAGNOSTICS / REPAIRS

- Clean only with a soft wet cloth.
- Do not use aggressive detergents or products.
- Do not clean equipment with direct water jets.

Troubleshooting

FAULT	CAUSE	REMEDY
VISIO is off or does not switch on	No power supply	Check power cable connections
	Device is OFF	Press the ON key
VISIO shows wrong data	Wrong setup	Check displayed data setup
	Sensor fault	Contact the nearest Assistance Center
	VISIO fault	
Filling pump (if any) does not start	Pump Stop Module not powered	Check power supply connection

END OF LIFE DISPOSAL

Dispose of the system in compliance with the established legislation in the country of use.

TECHNICAL DATA

Device technical data

Description	VISIO
Display	Graphic LCD, 128 x 64 pixels, back-lighting
Power supply voltage	9 ÷ 16 Vdc
Protection against short-circuit	•
Protection against polarity inversion	•
Max. frequency	1.2 KHz
Analog inputs	4 ÷ 20 mA
Digital output - Max current	100 mA
Maximum power input (with no sensors connected)	160 mA
Operating temperature	-20 °C ÷ 70 °C -4 °F ÷ +158 °F
Storage temperature	-30 °C ÷ 80 °C -22 °F ÷ +176 °F
Size	126 x 79 x 66 mm
Weight	245 g

Setup menu

	Data	Min.	Max.	Default	UoM	Notes
Flowmeter	Calibration	1	10000	OFF	pls/l	--
Alarms	Flowrate	0.1	1000.0	OFF	l/min.	Alarm can be disabled by setting value to "OFF"
	Speed	1.0	100.0	OFF	km/h	Alarm can be disabled by setting value to "OFF"
	Application rate	1.0	1000.0	OFF	l/ha	Alarm can be disabled by setting value to "OFF"
Display	Contrast	0	100	50	%	--
Options	Language	-	-	English	-	Available languages: Italiano, English, Español, Português, Français, Deutsch, Cesky, Polski, Русский, Magyar, 日本語.
	Flowrate units of measurement	-	-	l/min.	l/min.	Available units of measurement: l/min, GPM, m ³ /h
	Volume units of measurement	-	-	l	liters	Available units of measurement: l, gal, m ³
	Speed units of measurement	-	-	km/h	km/h	Available units of measurement: km/h, MPH
	Length units of measurement	-	-	m	m	Available units of measurement: m, ft
	Surface units of measurement	-	-	ha	ha	Available units of measurement: ha, ac, ksqft
	Application rate units of measurement	-	-	l/ha	l/ha	Available units of measurement: l/ha, GPA, GPK
	Distance units of measurement	-	-	km	km	Available units of measurement: km, miles

GUARANTEE TERMS

1. ARAG s.r.l. guarantees this apparatus for a period of 360 days (1 year) from the date of sale to the client user (date of the goods delivery note).
The components of the apparatus, that in the unappealable opinion of ARAG are faulty due to an original defect in the material or production process, will be repaired or replaced free of charge at the nearest Assistance Center operating at the moment the request for intervention is made. The following costs are excluded:
 - disassembly and reassembly of the apparatus from the original system;
 - transport of the apparatus to the Assistance Center.
2. The following are not covered by the guarantee:
 - damage caused by transport (scratches, dents and similar);
 - damage due to incorrect installation or to faults originating from insufficient or inadequate characteristics of the electrical system, or to alterations resulting from environmental, climatic or other conditions;
 - damage due to the use of unsuitable chemical products, for spraying, watering, weedkilling or any other crop treatment, that may damage the apparatus;
 - malfunctioning caused by negligence, mishandling, lack of know how, repairs or modifications carried out by unauthorized personnel;
 - incorrect installation and regulation;
 - damage or malfunction caused by the lack of ordinary maintenance, such as cleaning of filters, nozzles, etc.;
 - anything that can be considered to be normal wear and tear.
3. Repairing the apparatus will be carried out within time limits compatible with the organizational needs of the Assistance Center.
No guarantee conditions will be recognized for those units or components that have not been previously washed and cleaned to remove residue of the products used;
4. Repairs carried out under guarantee are guaranteed for one year (360 days) from the replacement or repair date.
5. ARAG will not recognize any further expressed or intended guarantees, apart from those listed here.
No representative or retailer is authorized to take on any other responsibility relative to ARAG products.
The period of the guarantees recognized by law, including the commercial guarantees and allowances for special purposes are limited, in length of time, to the validities given here.
In no case will ARAG recognize loss of profits, either direct, indirect, special or subsequent to any damage.
6. The parts replaced under guarantee remain the property of ARAG.
7. All safety information present in the sales documents regarding limits in use, performance and product characteristics must be transferred to the end user as a responsibility of the purchaser.
8. Any controversy must be presented to the Reggio Emilia Law Court.

Conformity Declaration



ARAG s.r.l.
Via Palladio, 5/A
42048 Rubiera (RE) - Italy
P.IVA 01801480359

Dichiara

che il prodotto
descrizione: **Visualizzatore multifunzione**
modello: **Visio**
serie: **4670610**

risponde ai requisiti di conformità contemplati nella seguente Direttiva Europea:
2004/108/CE e successive modificazioni
(Compatibilità elettromagnetica)

Riferimenti alle Norme Applicate:
UNI EN ISO 14982
(Macchine agricole e forestali - Compatibilità elettromagnetica
Metodi di prova e criteri di accettazione)

Rubiera, 6 Marzo 2013

Giovanni Montorsi



(Presidente)

Only use genuine ARAG accessories or spare parts to make sure manufacturer guaranteed safety conditions are maintained in time. Always refer to ARAG spare parts catalog.



42048 RUBIERA (Reggio Emilia) - ITALY
Via Palladio, 5/A

Tel. +39 0522 622011

Fax +39 0522 628944

www.aragnet.com

info@aragnet.com